

# 23

## WERFVERLICHTING EN ELEKTRICITEIT *LAMPES DE CHANTIER ET ÉLECTRICITÉ*

WERFLAMPEN	<i>LAMPES DE CHANTIER</i>
VERVANGLAMPEN	<i>LAMPES DE RECHANGE</i>
ZAKLAMPEN	<i>LAMPES TORCHES</i>
HOOFDLAMPEN	<i>LAMPES FRONTALES</i>
VERLENGKABELS EN STEKKERS	<i>RALLONGES ET PRISES</i>
KABELHASPELS	<i>ENROULEURS DE CÂBLE</i>
VERDEELKASTEN	<i>COFFRET DE DISTRIBUTION</i>
BATTERIJEN	<i>PILES</i>



**LUMX**  
POWER & LIGHTING

**LENA**  
LIGHTING

**Panasonic** **DURACELL**

## TAB/FLATO LED



**4600  
Lumen**

**TAB/FLATO LED**  
SMD LED TECHNOLOGY  
**47W**



Verstelbaar • Réglable

**"TAB/FLATO LED 47W" - mobiele bouwlamp met verstelbare steun**  
**"TAB/FLATO LED 47W" - lampe de chantier mobile avec support ajustable**

code							€
NI 622199	5905963622199	47 W	261 x 236 x 64 mm	1,000 Kg	-	1 1	<b>54,80</b>

## MAGNUM MULTI BATTERY M



**NEW**



Batterij niet inbegrepen  
Batterie non incluse



**MULTI BATTERY M**  
SMD LED TECHNOLOGY  
**4050  
Lumen**  
**32W**

**"MAGNUM MULTI BATTERY M" - Bosch + adapter Makita incl.**  
**mobile bouwlamp met verstelbare steun**  
**"MAGNUM MULTI BATTERY M" - Bosch + adaptateur Makita incl.**  
**lampe de chantier mobile avec support ajustable**

NI 608544  
MILWAUKEE  
DEWALT



NI 608605  
MAKITA

code							€
NI 249433	5905963249433	32 W	400 x 300 x 75 mm	2,170 Kg	51	1 1	<b>225,00</b>
<b>Adapter MILWAUKEE - DEWALT • Adaptateur MILWAUKEE - DEWALT</b>							
NI 608544	5905963608544	18V	-	0,136 Kg	-	1 1	<b>28,00</b>
<b>Adapter MAKITA • Adaptateur MAKITA</b>							
NI 608605	5905963608605	18V	-	0,136 Kg	-	1 1	<b>28,00</b>

**MAGNUM FUTURE LED**



**4300**  
Lumen

**Future LED**  
SMD LED TECHNOLOGY  
**32W**

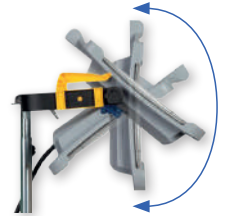

Verstelbaar • Réglable



Connecteer • Connector

**"MAGNUM FUTURE LED" 32 W - mobiele bouwlamp met verstelbare steun**  
**"MAGNUM FUTURE LED" 32 W - lampe de chantier mobile avec support ajustable**

code								min.	€
NI 247002		5905963247309	32 W	400 x 300 x 100 mm	3,995 kg	51	1	1	<b>135,00</b>

**MAGNUM FUTURE LITE, XL - XL MAX**



**Future LITE**  
SMD LED TECHNOLOGY  
**50W**



**5500**  
Lumen



**Future XL**  
SMD LED TECHNOLOGY  
**50W**

**6500**  
Lumen

**Future XL MAX**  
SMD LED TECHNOLOGY  
**78W**

**11000**  
Lumen

**"MAGNUM FUTURE LITE, XL en XL MAX" - mobiele bouwlamp met verstelbare steun**  
**"MAGNUM FUTURE LITE, XL et XL MAX" - lampe de chantier mobile avec support ajustable**

code								min.	€
<b>LITE</b>				mm					
NI 406294		5905963406294	50 W	480 x 300 x 75	3,550 kg	66	1	1	<b>127,00</b>
<b>XL</b>									
NI 247903		5905963247903	50 W	480 x 295 x 75	4,500 kg	66	1	1	<b>180,00</b>
<b>XL MAX</b>									
NI 248900		5905963248900	78 W	480 x 300 x 75	4,500 kg	66	1	1	<b>199,00</b>

## GALAXY COMPACT

CLASS 1
 IP 54
 3m H07RN-F (3G 1,5 mm<sup>2</sup>) NEOPRENE
 16A + T
 USB connection
 ON/OFF SWITCH
 ENERGY SAVING
 6500 °K
 CE



P. 510



**GALAXY COMPACT**  
SMD LED TECHNOLOGY  
**24W**

2500 Lumen

"GALAXY COMPACT LED" 24 W  
"GALAXY COMPACT LED" 24 W

code								min.	€
LM 32232		5420000059320	24 W	290 x 234 x 83 mm	1,720 kg	120	6	1	63,30

## GALAXY-Serie

CLASS 1
 IP 54
 3m H07RN-F (3G 1,5 mm<sup>2</sup>) NEOPRENE
 16A + T
 50-100% SWITCH
 ENERGY SAVING
 6500 °K
 CE
 3 year WARRANTY ON THE LED



P. 510



4950 Lumen

**GALAXY**  
SMD LED TECHNOLOGY  
**45W**

9200 Lumen

**GALAXY XL**  
SMD LED TECHNOLOGY  
**80W**

"GALAXY LED" - mobiele bouwlamp met verstelbare steun  
"GALAXY LED" - lampe de chantier mobile avec support ajustable

code								min.	€
LM 32245		5420000046498	45 W	385 x 315 x 90 mm	2,300 kg	96	4	1	85,30
LM 32300		5420000065017	80 W	464 x 365 x 84 mm	2,300 kg	64	4	1	130,00

Geschikt voor statief  
Apte pour trépied  
LM 0225E

**LED F-Serie**

CLASS 1 IP 65 ENERGY SAVING 6500 °K CE



1,8m  
H07RN-F  
(3G 1,0 mm<sup>2</sup>)  
NEOPRENE

**LED F-20**

SMD LED TECHNOLOGY

**1800  
Lumen**

**20W**



3m  
H07RN-F  
(3G 1,0 mm<sup>2</sup>)  
NEOPRENE

**LED F-30**

SMD LED TECHNOLOGY

**2500  
Lumen**

**30W**



3m  
H07RN-F  
(3G 1,0 mm<sup>2</sup>)  
NEOPRENE

**LED F-50**

SMD LED TECHNOLOGY

**4200  
Lumen**

**50W**

LED straler F-20 / F-30 / F-50 • Projecteur LED F-20 / F-30 / F-50

code									min.	€
				mm						
LM 36120		5420000049536	20 W	264 x 238,5 x 148,6	1,438 kg	160	8	1		<b>31,20</b>
LM 36130		5420000049543	30 W	288,6 x 288 x 168,5	1,994 kg	120	6	1		<b>46,80</b>
LM 36150		5420000049550	50 W	318,5 x 308 x 183	2,250 kg	96	4	1		<b>60,30</b>



**LED FT-Serie**

CLASS 1 IP 65 3m H07RN-F (3G 1,0 mm<sup>2</sup>) NEOPRENE ENERGY SAVING 6500 °K CE



**LED FT-50**  
SMD LED TECHNOLOGY  
**50W**

**4200  
Lumen**

min. 0,95 m - max. 1,63 m



**LED FT-60**  
SMD LED TECHNOLOGY  
**2 x 30W**

**5000  
Lumen**

min. 0,92 m - max. 1,66 m

LED straler FT-50 / FT-60  
Projecteur LED FT-50 / FT-60

code									min.	€
				mm						
LM 36500		5420000063280	50 W	260 x 285 x 40	5,500 kg	18	2	1		<b>73,40</b>
LM 36660		5420000060135	60 W	570 x 250 x 40	6,100 kg	24	2	1		<b>91,70</b>

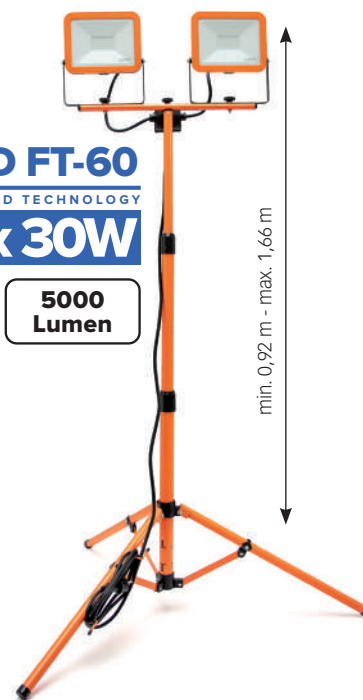

## LED P+ 60 / LED P+ 100

CLASS 1
 IP 54
 3m H07RN-F (3G 1,5 mm<sup>2</sup>) NEOPRENE
 16A + T
 ON/OFF SWITCH
 50-100% SWITCH
 2x USB connection
 ENERGY SAVING
 CE



**NEW**



**ALL-IN-ONE**

COLOR TEMPERATURE SELECTION

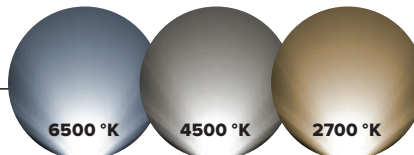

8800 Lumen

**LED P+100**  
SMD LED TECHNOLOGY  
**100W**



5300 Lumen

**LED P+60**  
SMD LED TECHNOLOGY  
**60W**

LED P+60 / LED P+100 "HIGH POWER" straler  
LED P+60 / LED P+100 "HAUTE PUISSANCE"

code								min.	€	
				mm						
LM 33595		5420000065000		60 W	300 x 305,5 x 82	2,825 kg	96	4	1	<b>118,00</b>
LM 33600		5420000063273		100 W	368 x 346 x 92	4,254 kg	80	4	1	<b>148,00</b>

## LED P-80

CLASS 1
 IP 54
 3m H07RN-F (3G 1,5 mm<sup>2</sup>) NEOPRENE
 16A + T
 ON/OFF SWITCH
 ENERGY SAVING
 4000°K
 CE

7200 Lumen

**LED P-80**  
SMD LED TECHNOLOGY  
**80W**

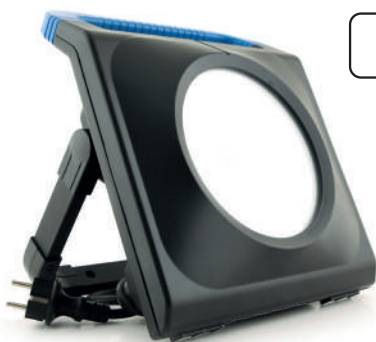

LED P-80 "HIGH POWER" straler  
LED P-80 "HAUTE PUISSANCE"

code								min.	€	
				mm						
LM 33580		5420000042483		80 W	342 x 295 x 112	1,125 kg	48	4	1	<b>113,00</b>

## LED LB-50

CLASS 1
 IP 54
 5m H07RN-F (3G 1,5 mm<sup>2</sup>) NEOPRENE
 16A + T
 ON/OFF SWITCH
 ENERGY SAVING
 6000°K
 CE

5500 Lumen

**LED LB-50**  
SMD LED TECHNOLOGY  
**50W**



LED LB-50 Power worklight 360° • LED LB-50 Power worklight 360°

code								min.	€	
				mm						
LM 37500		5420000062153		50 W	280 x 286 x 280	2,600 kg	40	4	1	<b>89,80</b>

## LED N-Serie



**LED N-50**

SMD LED TECHNOLOGY

**4580 Lumen**

**50W**



**LED N-80**

SMD LED TECHNOLOGY

**7200 Lumen**

**80W**

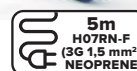

**LED N-120**

SMD LED TECHNOLOGY

**10800 Lumen**

**120W**

### LED straler N-Serie • Projecteur LED N-Série

code							min.	€	
			mm						
LM 34750		5420000060050	50 W	330 x 315 x 220	3,115 kg	32	4	1	<b>92,00</b>
LM 34780		5420000060067	80 W	400 x 354 x 258	4,682 kg	36	3	1	<b>145,00</b>
LM 34812		5420000060074	120 W	500 x 440 x 295	7,500 kg	12	2	1	<b>243,00</b>



## LED B-180



**16000 Lumen**

**LED B-180**

SMD LED TECHNOLOGY

**180W**



### LED straler B-180 • Projecteur LED B-180

code							min.	€	
			mm						
LM 35180		5420000060128	180 W	530 x 400 x 360	9,100 kg	16	2	1	<b>279,00</b>

## LL-24

CLASS 1
 IP 65
 10m H07RN-F (3G 1,5 mm<sup>2</sup>) NEOPRENE
 16A + T
 120 cm
 ENERGY SAVING
 6400 °K
 CE



Max. 10

CLIPS INCLUDED



2650 Lumen

LL-24  
SMD LED TECHNOLOGY  
**24W**

LED LL-24 Doorlusverlichting 24W • LED LL-24 éclairage en boucle 24W

code							min.	€
LM 36724			mm					
	5420000062177	24 W	1200 x 72 x 280	1,120 kg	90	6	1	68,40

## LS-45

CLASS 2
 IP 65
 1,5m H05RN-F (2X 1,0 mm<sup>2</sup>) NEOPRENE
 60 LED/m
 ENERGY SAVING
 6500 °K
 CE

**NEW**

**45+5 m** FREE GRATUIT GRATIS



inclusief stekker  
prise incluse

200 Lumen/m

LS-45  
SMD LED TECHNOLOGY  
**230W**



INHOUD - CONTENU :

- 1x T-connector
- 3x Pin-connector
- 3x Eindstuk/embout
- 1x PVC lijm/colle
- 1x EU stekker/fiche + kabel/câble 1,5m H05RN-F 2X 1,0 mm<sup>2</sup>

LED lichtslang - 45 m • Bande LED - 45 m

code							min.	€
LM 23046			mm					
	5420000065383	5 W / m	264 x 251 x 128	4,300 kg	96	1	1	129,00
Toeberehen voor LS-45 • Accessoires pour LS-45								
LM 23050				0,240 kg		50	1	14,70



**LED HP-Serie**



P. 510

**LED HP-150**

SMD LED TECHNOLOGY

**150W**

**13400 Lumen**

**LED HP-200**

SMD LED TECHNOLOGY

**200W**

**18250 Lumen**

**LED HP-400**

SMD LED TECHNOLOGY

**400W**

**37600 Lumen**



**60000 Lumen**

**LED HP-600**

COB LED TECHNOLOGY

**600W**

**HIGH LUMEN**

LED straler HP-Serie • Projecteur LED HP-Série

code								min.	€	
				mm						
LM 61015		5420000060098		150 W	345 x 280 x 68	6,500 kg	48	2	1	<b>222,00</b>
LM 61020		5420000060104		200 W	425 x 325 x 77	9,000 kg	32	2	1	<b>279,00</b>
LM 61040		5420000060111		400 W	595 x 475 x 95	14,000 kg	18	1	1	<b>498,00</b>
LM 61260		5420000064836		600 W	560 x 470 x 110	18,500 kg	12	1	1	<b>554,00</b>



**LED WS-Serie**



**WS-20**

SMD LED TECHNOLOGY

**20W**

**1800 Lumen**

**WS-30**

SMD LED TECHNOLOGY

**30W**

**2500 Lumen**

**WS-50**

SMD LED TECHNOLOGY

**50W**

**4200 Lumen**



**LED WSS-Serie**



**WSS-20**

SMD LED TECHNOLOGY

**20W**

**1800 Lumen**

**WSS-30**

SMD LED TECHNOLOGY

**30W**

**2500 Lumen**

**WSS-50**

SMD LED TECHNOLOGY

**50W**

**4200 Lumen**

LED wandstraler • Projecteur murale LED

code								min.	€	
				mm						
<b>WS-Serie • WS-Série</b>										
LM 31320		5420000063785		20 W	192 x 70 x 135	0,640 kg	350	10	1	<b>21,09</b>
LM 31330		5420000063792		30 W	224 x 80 x 201	1,150 kg	288	8	1	<b>30,30</b>
LM 31350		5420000063808		50 W	278 x 75 x 204	1,450 kg	180	6	1	<b>43,90</b>
<b>WSS-Serie met sensor • WSS-Série avec détecteur</b>										
LM 31720S		5420000063815		20 W	192 x 60 x 225	0,710 kg	300	10	1	<b>26,90</b>
LM 31730S		5420000063822		30 W	224 x 80 x 250	1,210 kg	144	8	1	<b>40,90</b>
LM 31750S		5420000063839		50 W	278 x 70 x 335	1,550 kg	108	6	1	<b>55,60</b>





**LED R-Serie**

CLASS 3 
 IP 54 
 4000 °K 
 incl. 
 MAGNETIC feet 
 ENERGY SAVING 
 CE

±3-4 hrs

±2,5 hrs

7,4 V  
2200 mAh  
LITHIUM

**800 Lumen**

**LED R-10**  
SMD LED TECHNOLOGY  
**10W**  
RECHARGEABLE



±5-6 hrs

±2,5 hrs

7,4 V  
4400 mAh  
LITHIUM

**1600 Lumen**

**LED R-20**  
SMD LED TECHNOLOGY  
**20W**  
RECHARGEABLE



LED R-10 / R-20 straler op voet • Projecteur LED R-10 / R-20 sur pied

code							min.	€	
			mm						
LM 32010		5420000049581	10 W	239 x 167 x 118	1,040 kg	288	12	1	<b>56,30</b>
LM 32020		5420000049598	20 W	286,5 x 221,5 x 133	1,650 kg	144	8	1	<b>82,80</b>

**Dual LED RS-50**

5000 °K 
 ENERGY SAVING 
 CE

P. 510



DUAL SYSTEM



MAGNETIC feet



**5000 Lumen**

**LED RS-50**  
COB LED TECHNOLOGY  
**50W**  
RECHARGEABLE/220V

CLASS 3 
 CLASS 2 
 IP 54 
 IP 44 
 Changeable battery 
 5m H05RN-F (2X 1,0 mm<sup>2</sup>) NEOPRENE 
 ON/OFF SWITCH 
 50-100% SWITCH 
 POWER BANK FUNCTION 
 USB rechargeable

digitale indicator van het batterijniveau  
indicateur digitale du niveau de batterie



DUAL LED RS-50 • DUAL LED RS-50

code							min.	€		
			mm							
LM 30350		5420000049567	50 W	300 x 265 x 130	3,110 kg	96	-	4	1	<b>138,40</b>
Reserve accu voor LM 30350 • Batterie de recharge pour LM 30350										
LM 30355		5420000049574	7,4V / 8800mAh	-	0,625 kg	-	30	1	1	<b>63,30</b>

Inclusief batterij • Batterie inclus



LM 30355

## PL-108

CLASS 1
 IP 54
 5m H07RN-F (3G 1,5 mm²) NEOPRENE
 16A + T
 INCLUSIVE 3x
 6400 °K
 ENERGY SAVING
 CE



P. 510



8250  
Lumen

PL-108

108W

3 x 36W

PL-108 werflamp • Lampe de chantier PL-108



LM 25936

code								min.	€
LM 25108		5420000062160	108 W	545 x 270 x 110	5,000 kg	60	5	1	106,00
PL vervanglamp 36W 4 pinnen • Lampe de recharge PL 36W 4 broches									
LM 25936		5420000064270	36 W - Class A	230	0,206 kg	-	50	1	9,00

## STATIEVEN • TRÉPIEDS



LM 0225E



max  
60 kg

LM 03305

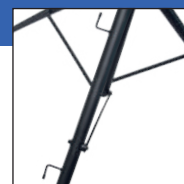

kabelprolsysteem  
système d'enroulage de câble



extra beveiliging  
broche anti-chute

code							min.	€
Statief voor PL- en LED-stralers • Trépied pour projecteurs PL et LED								
LM 0225E		5420000018938	1,09 → 2,75 m	6,150 kg	36	3	1	53,50
Statief Heavy Duty • Trépied Heavy Duty								
LM 03305		5420000062412	1,40 → 3,00 m	7,100 kg	36	2	1	110,00

	LM 0225E	LM 03305
NI 247002	✓	-
NI 249433	✓	-
NI 406294	✓	-
NI 247903	✓	-
NI 248900	✓	-
LM 32245	✓	✓
LM 32300	✓	✓
LM 32232	✓	✓
LM 33580	✓	-
LM 33595	✓	-
LM 33600	✓	-
LM 37500	✓	-
LM 61015	✓	✓
LM 61020	✓	✓
LM 61040	✓	✓
LM 61260	✓	✓
LM 32230	✓	✓
LM 32228	✓	✓
LM 30350	✓	-
LM 25108	✓	✓

## Camelion



**20  
Lumen**

**Spatwaterbestendige zaklamp "FL-16 LED"**  
**Torche résistante aux éclaboussures "FL-16 LED"**

code		lumen				min.	€
PS 011187		20 lm	100 x 180 x 130 mm	0,399 kg	-	12 1	<b>17,67</b>

Batterij excl. • Pile excl.

## LM 16330



**330  
Lumen**



met draaglint  
avec bandoulière



kantelbaar  
inclinable

**LED zaklamp waterproof • Torche LED étanche**

code		lumen				min.	€
LM 16330		330 lm	188 x 148 x 128 mm	0,476 kg	72	12 1	<b>35,40</b>

Batterij excl. • Pile excl.

## T-GUN 950 SPOT LIGHT



Handvrij  
Mains libres

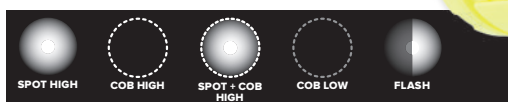

**950  
Lumen**

**LED T-GUN 950 spot light / oplaadbaar / IP67**  
**LED T-GUN 950 spot light / rechargeable / IP67**

code		lumen				min.	€
LM 18625		950 lm	148 x 165 x 76 mm	0,500 kg	12 3	1	<b>80,80</b>

### PEN LIGHT - display 16 st/pcs

CLASS 3
 IP 20
 6500 °K
 6 LED
 3 x AAA (incl.)
 ±4 hrs
 ENERGY SAVING
 CE

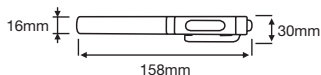

**STRONG ALU BODY**

**200 Lumen**

**PEN LIGHT**  
SMD LED TECHNOLOGY  
**BATTERY**



code	display	barcode	mm	weight	units	min.	€
LM 51955	display	5420000042445	158 x 30 x 16	0,056 kg	1536	64	16
							<b>11,50</b>

Prijs per stuk • Prix par pièce

### DUO LED - display 12 st/pcs

CLASS 3
 IP 20
 4000 °K
 20+3 LED
 3 x AAA (incl.)
 ±10 hrs
 ENERGY SAVING
 CE

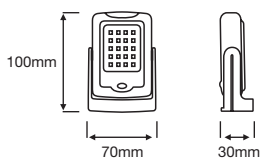

**DUO LED**  
BULB & SMD LED TECHNOLOGY  
**BATTERY**



code	display	barcode	mm	weight	units	min.	€
LM 52000	display	5420000039285	100 x 70 x 30	0,094 kg	864	48	12
							<b>8,20</b>

Prijs per stuk • Prix par pièce

### LED DUO GRIP - display 9 st/pcs

CLASS 3
 IP 20
 7000 °K
 3 x AA (incl.)
 ±3 hrs
 ENERGY SAVING
 CE

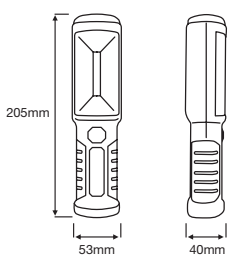

**MAGNETIC back**



**LED DUO GRIP**  
COB LED TECHNOLOGY  
**BATTERY**



code	display	barcode	mm	weight	units	min.	€
LM 52065	display	5420000046610	205 x 53 x 40	0,136 kg	648	36	9
							<b>10,65</b>

Prijs per stuk • Prix par pièce

## INSPEC DUO GRIP

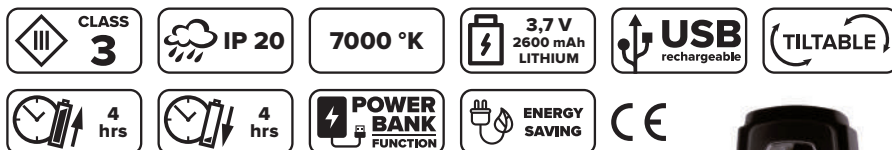

**INSPEC DUO GRIP**  
COB LED TECHNOLOGY  
**3W**  
RECHARGEABLE

**30 Lumen**

led bulb  
led à diode



360°



**300 Lumen**

**MAGNETIC**  
foot



code

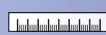

min.

€

LM 52111



542000062382

3 W

245 x 58,5 x 45,8

mm

0,387 kg

360

24

1

**26,17**

## INSPEC PRO

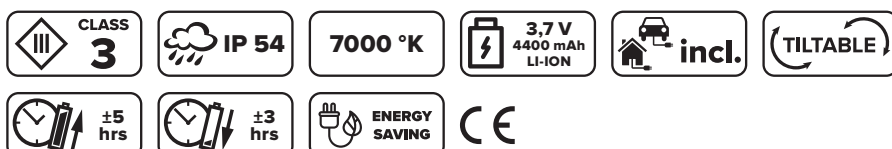

**INSPEC PRO**  
SMD LED TECHNOLOGY  
**5W**  
RECHARGEABLE

**80 Lumen**

led bulb  
led à diode



**MAGNETIC**  
foot

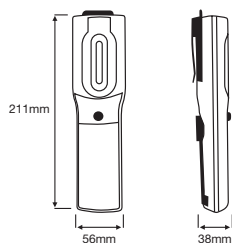

code

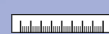

min.

€

LM 52125



5420000042490

5 W

211 x 56 x 38

mm

0,582 kg

360

20

1

**43,50**





## TURBO COMPACT



met LOCK-systeem  
avec LOCK-système

**3000  
Lumen**

**TURBO COMPACT**  
SMD LED TECHNOLOGY  
**28W**  
RECHARGEABLE

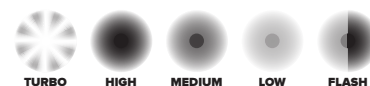

	Lm	m	⌚
TURBO	3000 Lm	375 m	± 1,5 u/h
HIGH	1000 Lm	220 m	± 3,5 u/h
MED	500 Lm	155 m	± 4 u/h
LOW	100 Lm	55 m	± 25 u/h
8Hz FLASHING	N/A	N/A	± 8 u/h



LED-zaklamp TURBO Compact High Power  
Torche LED TURBO Compact High Power

code	barcode	lumen	mm	weight	length	width	height	min.	€
LM 17130	koffer/coffre 542000060586	3000 lm	Ø 62 x 172	0,480 kg	-	2	1		<b>138,00</b>

## TURBO PRO



met LOCK-systeem  
avec LOCK-système

**3500  
Lumen**

**TURBO PRO**  
SMD LED TECHNOLOGY  
**28W**  
RECHARGEABLE

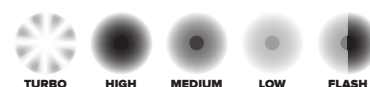

	Lm	m	⌚
TURBO	3500 Lm	400 m	± 2 u/h
HIGH	1500 Lm	275 m	± 3 u/h
MED	500 Lm	155 m	± 8 u/h
LOW	100 Lm	70 m	± 40 u/h
8Hz FLASHING	N/A	N/A	± 8 u/h



LED-zaklamp TURBO PRO High Power  
Torche LED TURBO PRO High Power

code	barcode	lumen	mm	weight	length	width	height	min.	€
LM 17005	koffer/coffre 542000060579	3500 lm	Ø 62 x 247	0,600 kg	72	2	1		<b>157,00</b>

#### HL-180

LIGHT BY CREE LEDs  
 IP X4  
 3 x AAA DURACELL (incl.)  
 SHOCK RESISTANT 1m  
 5200 °K 7200 °K  
 CE

180° kantelbaar  
 Inclinaison à 180°

Zelfklevende bevestiging voor veiligheidshelm  
 Support adhésif pour casque de sécurité

Met verschuifbare diffuser  
 Avec diffuseur coulissant



180 Lumen

6 modes



#### LED hoofdlamp HL-180 LED lampe frontale HL-180

code	lumen	mm	kg	mm	mm	mm	mm	mm	min.	€
LM 12180	180 lm	38 x 70 x 50	0,120	288	24	6	1	1	26,20	

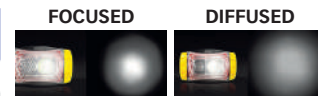

#### HL-250

LIGHT BY CREE LEDs  
 IP 64  
 SHOCK RESISTANT 2m  
 USB rechargeable  
 Changeable battery  
 6100 °K 7100 °K  
 CE

90° kantelbaar  
 Inclinaison à 90°

Verstelbare focus  
 Mise au point réglable

Dubbele lichtbron  
 Deux sources de lumière



250 Lumen

5 modes



#### LED hoofdlamp HL-250 met herlaadbare batterij LED lampe frontale HL-250 avec batterie rechargeable

code	lumen	mm	kg	mm	mm	mm	mm	mm	min.	€
LM 12325	250 lm	62 x 41 x 43	0,130	288	24	6	1	1	41,10	



LM 12997

Batterij voor LM 12325 • Batterie pour LM 12325

LM 12997	vrac	5420000061828	-	43 x 32 x 11	0,020	-	-	1	1	16,45
----------	------	---------------	---	--------------	-------	---	---	---	---	-------

#### TCT-250S

LUMILEDS The Brighter Choice  
 IP X4  
 3 x AAA DURACELL (incl.)  
 SHOCK RESISTANT 2m  
 6500 °K  
 CE

Met lichtsensoren  
 Avec capteur de lumière

Met pulse mode  
 Avec mode pulse

Met bewegingssensoren  
 Avec capteur de mouvement



250 Lumen

8 modes

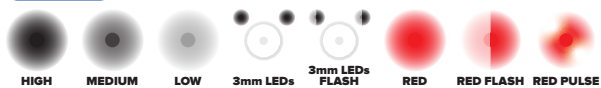

#### LED hoofdlamp TCT-250S met sensor LED lampe frontale TCT-250S avec sensor

code	lumen	mm	kg	mm	mm	mm	mm	mm	min.	€
LM 12440	250 lm	36 x 82 x 37	0,150	288	24	6	1	1	41,60	



**TCT-300**

LIGHT BY **CREE** LEDs  
**IP 64**  
 Incl. 3,7 V 2600 mAh Li-ion  
 ±4 hrs  
**7100 °K**  
**8300 °K**

**SHOCK RESISTANT**  
**2m**  
**USB rechargeable**  
**Changeable battery**



**6 modes**

HIGH MEDIUM LOW FLASH RED RED FLASH

**LED hoofdlamp TCT-300 met herlaadbare batterij  
LED lampe frontale TCT-300 avec batterie rechargeable**

code		lumen					min.	€	
LM 12590		300 lm	79 x 44 x 38 mm	0,240 kg	288	24	6	1	<b>54,40</b>
Batterij voor LM 12590 • Batterie pour LM 12590									
LM 12998		-	71 x Ø 19 mm	0,048 kg	-	-	1	1	<b>17,69</b>



**TCT-640**

**IP 66**  
**SHOCK RESISTANT**  
**2m**  
**USB rechargeable**  
**Changeable battery**  
**6500 °K**  
**7100 °K**

Incl. 3,8 V 1900 mAh LI-ION  
 of **3 x AA (not incl.)**



**6 modes**

HIGH MEDIUM LOW FLASH RED RED FLASH

**LED hoofdlamp TCT-640 herlaadbaar  
LED lampe frontale TCT-640 rechargeable**

code		lumen					min.	€	
LM 12600		640 lm	125 x 35 x 25 mm	0,200 kg	192	24	6	1	<b>62,70</b>
Batterij voor LM 12600 • Batterie pour LM 12600									
LM 12999		-	47 x 45 x 14 mm	0,040 kg	-	-	1	1	<b>24,16</b>









LM 40515  
LM 40526



LM 40745 - LM 40750  
LM 40755 - LM 40765  
LM 40770



### Verlengkabel - stopcontact met klapdeksel Rallonge - prise avec clapet

code									min.	€
<b>H05VV-F</b>										
LM 40515	vrac	5420000039681	15	3G 1,5 mm <sup>2</sup>	1,580 kg	200	8	1		<b>26,53</b>
LM 40526	vrac	5420000034945	25	3G 1,5 mm <sup>2</sup>	3,100 kg	144	4	1		<b>42,77</b>
<b>H07RN-F</b>										
LM 40745	vrac	5420000041554	5	3G 2,5 mm <sup>2</sup>	1,265 kg	200	20	1		<b>19,21</b>
LM 40750	vrac	5420000019607	10	3G 2,5 mm <sup>2</sup>	2,300 kg	144	8	1		<b>34,80</b>
LM 40755	vrac	5420000041561	15	3G 2,5 mm <sup>2</sup>	3,790 kg	90	5	1		<b>50,90</b>
LM 40765	vrac	5420000019614	25	3G 2,5 mm <sup>2</sup>	5,400 kg	104	2	1		<b>82,30</b>
LM 40770	vrac	5420000047488	40	3G 2,5 mm <sup>2</sup>	8,640 kg	60	2	1		<b>129,00</b>

LM 40453

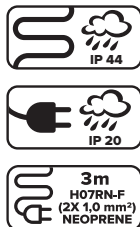

LM 40435



LM 40425



LM 40455



LM 40443 - LM 40445



Max. 3600 W

### Machine aansluitkabel Cordon de raccordement machine



EE 80600470

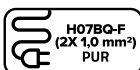

code									min.	€
<b>H05RN-F</b>										
LM 40425	vrac	5420000047334	5	2 x 1,0 mm <sup>2</sup>	0,420 kg	280	20	1		<b>6,41</b>
<b>H07RN-F</b>										
LM 40453	vrac	5420000041530	3	2 x 1,0 mm <sup>2</sup>	0,320 kg	450	30	1		<b>5,30</b>
LM 40455	vrac	5420000041547	5	2 x 1,0 mm <sup>2</sup>	0,510 kg	600	20	1		<b>7,68</b>
LM 40443	vrac	5420000041516	3	2 x 1,5 mm <sup>2</sup>	0,420 kg	270	30	1		<b>5,93</b>
LM 40445	vrac	5420000041523	5	2 x 1,5 mm <sup>2</sup>	0,696 kg	280	20	1		<b>9,81</b>
LM 40435	vrac	5420000041509	5	3G 1,5 mm <sup>2</sup>	0,850 kg	280	20	1		<b>11,87</b>
<b>H07BQ-F</b>										
EE 80600470	vrac	5420000058996	3	2 x 1,0 mm <sup>2</sup>	0,100 kg	-	1	1		<b>14,97</b>



LM 48521

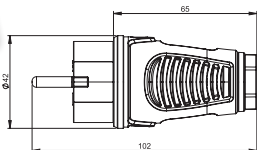

LM 48411

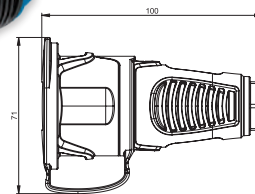

**Stekker en stopcontact - 2P + A**  
**Prise mâle et prise femelle - 2P + T**

230V - 50Hz

code							min.	€
<b>Stekker • Prise mâle</b>								
LM 48521	vrac	5420000046900		rubber / caoutchouc	0,072 kg	-	30	1 <b>4,01</b>
<b>Stopcontact met klapdeksel • Prise femelle avec clapet</b>								
LM 48411	vrac	5420000046917		rubber / caoutchouc	0,102 kg	-	20	1 <b>7,14</b>

LM 48585

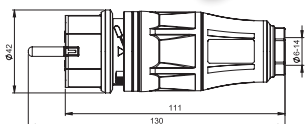

LM 48455

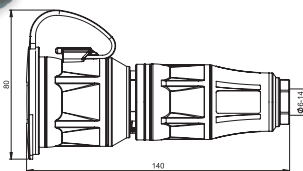

**Stekker en stopcontact "Dual System" - 2P + A**  
**Prise mâle et prise femelle "Dual System" - 2P + T**

230V - 50Hz

code							min.	€
<b>Stekker • Prise mâle</b>								
LM 48585	vrac	5420000046931		rubber / caoutchouc	0,094 kg	-	20	1 <b>5,45</b>
<b>Stopcontact met klapdeksel • Prise femelle avec clapet</b>								
LM 48455	vrac	5420000046924		rubber / caoutchouc	0,134 kg	-	10	1 <b>7,76</b>



LM 48200

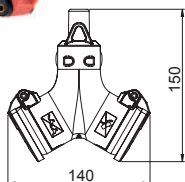

LM 48300



LM 48310  
LM 48325



230V - 50Hz

**Contactblok met klapdeksels - 2P + A**  
**Prise à clapets - 2P + T**

code							min.	€
<b>Dubbel • Double</b>								
						m		
LM 48200	vrac	5420000046979		-	0,222 kg	-	10	1 <b>22,78</b>
<b>3-voudig • Triple</b>								
LM 48300	vrac	5420000046948		-	0,317 kg	-	5	1 <b>35,30</b>
LM 48310	zakje/sachet	5420000046955	10	H07RN-F/3G 2,5 mm <sup>2</sup>	5,350 kg	-	1	1 <b>78,70</b>
LM 48325	zakje/sachet	5420000046962	25	H07RN-F/3G 2,5 mm <sup>2</sup>	6,100 kg	-	1	1 <b>118,00</b>

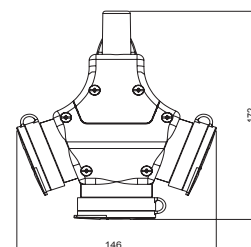



## Driewegskoppelstekker • Fiche femelle triple

250V - 16A

code							min.	€
NI 243300		5420000039612	block	0,220 kg	-	50	1	9,74
NI 243303		5420000039629	0,3 m kabel / câble 0,3 m	0,370 kg	-	30	1	17,80
NI 243305		5420000039636	5 m kabel / câble 5 m	1,370 kg	-	20	1	31,10
NI 243310	polybag	5420000039643	10 m kabel / câble 10 m	2,520 kg	-	8	1	52,50
NI 243325	polybag	5420000039650	25 m kabel / câble 25 m	5,970 kg	-	4	1	105,00

Verdeelblok met 4 stopcontacten en schakelaar - EN60309  
Bloc multiprises avec 4 prises et interrupteur - EN60309

250V - 16A

code							min.	€
LM 41200	polybag	5420000046542	block	0,458 kg	-	10	1	25,36
LM 41203	polybag	5420000046559	3 m kabel / câble 3 m	1,118 kg	-	10	1	39,20
LM 41210	polybag	5420000046566	10 m kabel / câble 10 m	2,200 kg	-	4	1	57,90

LM 40803

LM 40814

LM 40913

LM 40826

NEW



## Stekkerdoos met schakelaar • Prise avec interrupteur

250V - 50Hz

code							min.	€
<b>3-voudig • Triple</b>								
LM 40803	vrac	5420000043954	1,5 m kabel / câble 1,5 m	0,263 kg	-	40	1	6,94
<b>4-voudig • Quadruple</b>								
LM 40814	vrac	5420000043961	3 m kabel / câble 3 m	0,429 kg	-	30	1	9,79
<b>6-voudig • Sextuple</b>								
LM 40826	vrac	5420000058903	5 m kabel / câble 5 m	0,742 kg	-	20	1	14,05
<b>3-voudig + 2 USB-connecties • Triple + 2 connections USB</b>								
LM 40913	vrac	5420000064898	1,5 m kabel / câble 1,5 m	0,388 kg	-	40	1	10,12





«COMPACT» CEE VERDEELKASTEN : SERIES ST. ANTON  
COFFRETS DE DISTRIBUTION CEE «COMPACT» : SERIES ST. ANTON

De «compact» CEE verdeelkasten zijn ontworpen voor een veilig, betrouwbaar en gemakkelijk gebruik.

- compacte vorm gemaakt van schokbestendige polyamide (thermoplastisch)
- ergonomisch design
- klaar bekabeld voor aansluiting
- spatbestendig

Les coffrets de distribution CEE «compact» sont conçus pour une utilisation sûre, fiable et facile.

- forme compacte en polyamide résistant aux chocs (thermoplastique)
- design ergonomique
- prêt à l'utilisation
- résistant aux éclaboussures



LM 46101



LM 46105



ISO 9001

code							min.	€
LM 46101		5420000049376	mm 240 x 100 x 80	0,565 kg	-	2	1	<b>40,00</b>
Met kabel • Avec câble								
LM 46105		5420000047099	240 x 100 x 80	1,120 kg	-	2	1	<b>113,00</b>

	LM 46101	LM 46105
Invoer / Entrée	1 x CEE 16A - 5P - 400V	1 x CEE 16A - 5P - 400V
Uitvoer / Sortie	1 x CEE 16A - 5P - 400V 2 x 16A - 250V	
Kabel type / Type de câble	-	H07RN-F / 5G 2,5 mm <sup>2</sup>
Kabellengte / Longueur de câble	-	1,5 m
Stekkers / Prises	F  B	F  B



LM 46120



LM 46122



ISO 9001

code							min.	€
LM 46120		5420000047105	mm 200 x 170 x 80	0,744 kg	-	2	1	<b>45,60</b>
Met kabel • Avec câble								
LM 46122		5420000047112	240 x 170 x 80	1,320 kg	-	2	1	<b>93,80</b>

	LM 46120	LM 46122
Invoer / Entrée	1 x CEE 16A - 5P - 400V	1 x CEE 16A - 5P - 400V
Uitvoer / Sortie	3 x CEE 16A - 5P - 400V	
Kabel type / Type de câble	-	H07RN-F / 5G 2,5 mm <sup>2</sup>
Kabellengte / Longueur de câble	-	1,5 m
Stekkers / Prises	Universeel • Universel	



LM 46134



LM 46138



ISO 9001

code							min.	€
			mm					
LM 46134		5420000047129	240 x 170 x 80	0,622 kg	-	2	1	<b>41,20</b>
<b>Met kabel • Avec câble</b>								
LM 46138		5420000047136	240 x 170 x 80	1,002 kg	-	2	1	<b>111,00</b>

	LM 46134	LM 46138
<b>Invoer / Entrée</b>	1 x CEE 16A - 3P - 230V	1 x CEE 16A - 3P - 230V
<b>Uitvoer / Sortie</b>	3 x CEE 16A - 3P - 230V	
<b>Kabel type / Type de câble</b>	-	H07RN-F / 3G 2,5 mm <sup>2</sup>
<b>Kabellengte / Longueur de câble</b>	-	1,5 m
<b>Stekkers / Prises</b>	Universeel • Universel	



ISO 9001



code							min.	€
			mm					
LM 46478		5420000047150	200 x 100 x 80	0,459 kg	-	5	1	<b>34,70</b>

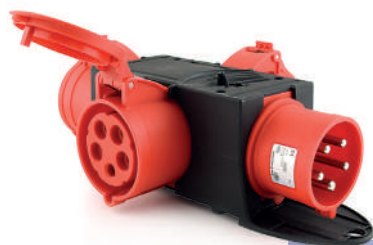

ISO 9001



code							min.	€
			mm					
LM 46413		5420000047143	295 x 190 x 100	1,118 kg	-	2	1	<b>78,40</b>

	LM 46478	LM 46413
<b>Invoer / Entrée</b>	1 x CEE 16A - 5P - 400V	1 x CEE 32A - 5P - 400V
<b>Uitvoer / Sortie</b>	3 x 16A - 250V	3 x CEE 32A - 5P - 400V
<b>Stekkers / Prises</b>	F  B	Universeel • Universel



Max. 6400 W

NI 031830  
 NI 031823



Met zekering  
Avec fusible

Max. 12800 W

NI 031786  
 NI 031854

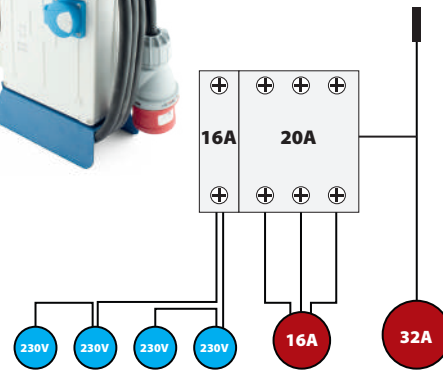

code								min.	€
------	--	--	--	--	--	--	--	------	---

NI 031830		5905963031830	260 x 210 x 180		2,782 kg	-	1	1	<b>98,20</b>
NI 031823		5905963031823	255 x 250 x 180		2,722 kg	-	1	1	<b>98,20</b>
<b>Met zekering • Avec fusible</b>									
NI 031786		5905963031786	350 x 210 x 180		4,720 kg	-	1	1	<b>182,00</b>
NI 031854		5905963318542	350 x 210 x 180		4,720 kg	-	1	1	<b>187,00</b>

	NI 031830	NI 031823	NI 031786	NI 031854
<b>Kabel type / Type de câble</b>	H07RN-F / 5G 2,5 mm <sup>2</sup>	H07RN-F / 5G 2,5 mm <sup>2</sup>	H07RN-F / 5G 4 mm <sup>2</sup>	H07RN-F / 5G 4 mm <sup>2</sup>
<b>Kabellengte / Longueur de câble</b>	1,5 m	1,5 m	4 m	4 m
<b>Max. Watt</b>	6400W	6400W	12800W	12800W
<b>Min. Watt</b>	960W	960W	-	-
<b>Invoer / Entrée</b>	CEE 16A - 5P	CEE 16A - 5P	CEE 32A - 5P	CEE 32A - 5P
<b>Uitvoer / Sortie</b>	2 x 400V (16A) 4 x 230V (FR/BE)	2 x 400V (16A) 4 x 230V (SCHUKO)	400V (1 x 32A - 1 x 16A) 4 x 230V (FR/BE)	400V (1 x 32A - 1 x 16A) 4 x 230V (SCHUKO)
<b>Stekkers / Prises</b>	 F B	 D L	 F B	 D L

**THERMOPLASTISCH GEÏSOLEERDE VERDEELKASTEN : SERIES IMST - EN 61439  
COFFRETS DE DISTRIBUTION ISOLÉS THERMOPLASTIQUES : SERIES IMST - EN 61439**

- handige, robuuste, mobiele verdeelkast gemaakt van schokbestendige polyamide
- met draagbeugel
- stapelbaar, met opbergsysteem voor de aansluitkabel

- coffret de distribution pratique, robuste, mobile fabriqué en polyamide résistant aux chocs
- avec poignée de transport
- empilable avec rangement pour le câble



LM 47110

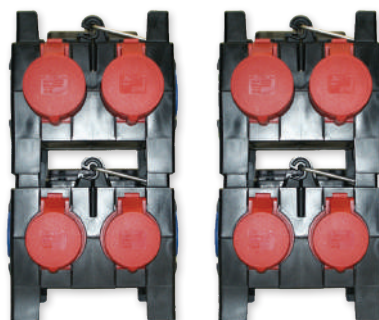

- ruimtebesparende opslag, boxen zijn stapelbaar
- gain d'espace de stockage car les boîtiers sont empilables



LM 47117

**Met zekering  
Avec fusible**

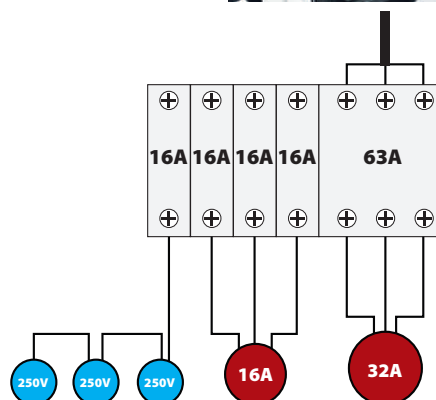

EN 61439

code			mm			min.	€
LM 47110			200 x 197 x 197	1,704 kg	-	1	128,00
<b>Met kabel en zekering • Avec câble et fusible</b>							
LM 47117			200 x 197 x 197	3,776 kg	-	1	350,00

	LM 47110	LM 47117
<b>Invoer / Entrée</b>	1 x CEE 16A - 5P - 400V	1 x CEE 32A - 5P - 400V
<b>Uitvoer / Sortie</b>	2 x CEE 16A - 400V 4 x 16A - 250V	1 x CEE 32A + 1 x 16A - 400V 3 x 16A - 250V
<b>Zekering / Fusible</b>	-	63 A
<b>Kabel type / Type de câble</b>	-	HO7RN-F 5G 4 mm <sup>2</sup>
<b>Kabellengte / Longueur de câble</b>	-	2 m
<b>Stekkers / Prises</b>		

## PLUS



**AAA**

ref. PS 040001



**AA**

ref. PS 040005



### LANGDURIG VERMOGEN GEGARANDEERD !

Duracell Plus Power staat voor betrouwbare prestaties en langdurig vermogen in een brede waaier van apparaten voor dagelijks gebruik. U kunt vertrouwen op Duracell Plus Power om uw afstandsbedieningen, cd-spelers, gemotoriseerd speelgoed, zaklampen, tandenborstels enz. van spanning te voorzien. Tot + 40 % meer vermogen (in digitale camera's, in vergelijking met Simply Duracell AA, verschillen de resultaten per apparaat). Langdurig vermogen gegarandeerd. Best geschikt voor een brede waaier van veelgebruikte apparaten. Verkrijgbaar in AA en AAA.

**100 % getest voor spanning en tegen lekkage.**

### PUISSANCE LONGUE DURÉE GARANTIE !

Duracell Plus Power vous offre une performance fiable et une puissance longue durée pour un large éventail d'appareils du quotidien. Vous pouvez compter sur Duracell Plus Power pour alimenter vos télécommandes, lecteurs de CD, jouets motorisés, lampes de poche, brosses à dents, etc... Jusqu'à 40% de puissance en plus (dans un appareil photo numérique par rapport aux piles Duracell Simply AA les résultats peuvent varier en fonction des appareils). Conçues pour une puissance longue durée pour un large éventail d'appareils du quotidien. Disponibles au format AA et AAA.

**100% testé contre les fuites.**

code				#/blister				min.	€
PS 040001		5000394018457	AAA / LR03	4	0,011 kg	-	10	1	<b>5,63</b>
PS 040005		5000394017641	AA / LR6	4	0,023 kg	-	20	1	<b>5,63</b>

## PRO Power



# PROCELL®

PROFESSIONAL BATTERIES BY DURACELL



**AAA**

ref. PS 12710

**AA**

ref. PS 12709

**9V**

ref. PS 12713

### De batterij voor de professionele gebruiker met langere levensduur

- Levert tot 30% meer vermogen tegen de meest voordelige prijs.
- Ontworpen om langer mee te gaan en verpakt voor grootverbruik en professionals.
- Meest geschikt voor professionele toestellen met hoog verbruik zoals zaklantaarn en andere krachtige apparaten.

### La batterie pour les utilisateurs professionnels avec une longue durée de vie

- Fournit jusqu'à 30% de puissance en plus pour un prix plus avantageux.
- Conçu pour durer plus longtemps et emballé pour les grands consommateurs et professionnels.
- Idéal pour les appareils professionnels à forte consommation tels que lampe de poche et autres appareils puissants.

code				#/box				min.	€
PS 12710		5000394136939	AAA / LR03	10	0,120 kg	-	10	10	<b>6,50</b>
PS 12709		5000394136830	AA / LR06	10	0,244 kg	-	10	10	<b>7,03</b>
PS 12713		5000394137097	9V / 6LR61	10	0,472 kg	-	5	5	<b>23,55</b>



- Alkaline kernproducten : ontworpen voor betrouwbare stroomvoorziening op alle plaatsen en alle tijdstippen
- Een volledig assortiment
- Ideaal voor apparaten met een hoog gemiddeld verbruik

- Piles alcalines coeur de gamme : conçues pour une alimentation fiable à tout moment et en tous lieux
- Un assortiment complet
- Idéales pour les appareils à consommation moyenne et élevée

code				#/blister				min.	€
PS 041030		5410853039006	AAA	4	0,011 kg	60	12	1	<b>3,86</b>
PS 041025		5410853038948	AA	4	0,023 kg	60	12	1	<b>3,86</b>
PS 041015		5410853038917	C	2	0,070 kg	60	12	1	<b>3,86</b>
PS 041020		5410853038887	D	2	0,143 kg	60	12	1	<b>6,09</b>
PS 041010		5410853038979	9V	1	0,044 kg	60	12	1	<b>4,40</b>

## Rechargeable



### HONDERDEN KEREN OPLAADBAAR !

Meest duurzame oplaadbare batterij, werking tot 5 jaar of 400 laadbeurten gegarandeerd. Vervaardigd met NiMH technologie voor optimale prestatie, zelfs bij lage temperaturen. Meest geschikt voor toestellen die veel energie verbruiken.

### LA PILE DURABLE, FOURNIE CHARGÉE.

Pile rechargeable la plus durable, fonctionnement jusqu'à 5 ans ou 400 recharges garanti. Fabriquée avec la technologie NiMH pour des prestations optimales, même à des températures basses. Le plus approprié pour des appareils qui consomment beaucoup d'énergie.

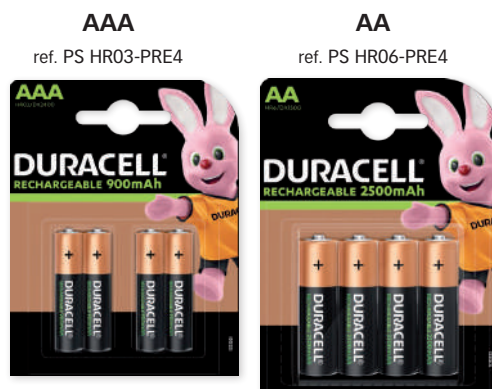

code				Min. cap.	#/blister				min.	€
PS HR03-PRE4		5000394203822	AAA / HR03	900 mAh	4	0,120 kg	-	10	1	<b>18,87</b>
PS HR06-PRE4		5000394057043	AA / HR6	2500 mAh	4	0,120 kg	-	10	1	<b>18,87</b>

### 45 minuten lader om AA- of AAA-NiMH-batterijen op te laden.

Geschikt voor alle oplaadbare AA- en AAA-NiMH-batterijen. Eenvoudig opladen, uitstekende prijs-kwaliteitverhouding.

### Charge les piles AA-NiMH et AAA-NiMH en 45 minutes.

Adapté à toutes les piles de type AA-NiMH et AAA-NiMH. Facile d'utilisation et excellent rapport qualité-prix.

code			Oplaatijd / Temps de charge	Pack				min.	€
PS 045050		5000394117211	45 min.	Oplader/chargeur + 2 x AA incl. + 2 x AAA incl.	0,208 kg	-	6	1	<b>33,13</b>



### 1-uur «HI-SPEED» multilader om AA, AAA, C, D en 9V NiMH-batterijen op te laden.

Eenvoudig opladen, uitstekende prijs-kwaliteitverhouding.

### «HI-SPEED» multichargeur, charge les piles AA, AAA, C, D, et 9V -NiMH en 1h.

Facile d'utilisation et excellent rapport qualité-prix.

code			Oplaatijd / Temps de charge	Pack				min.	€
PS 045100		5000394088313	1 h	Oplader/chargeur	0,506 kg	-	4	1	<b>62,07</b>

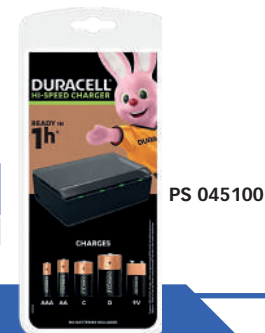

## LITHIUM Power



## CR-123

ref. PS 041115



## LRV08 / MN21-23GA

ref. PS 041110



- Zeer lange levensduur
- Ideaal voor oa. fotoapparaten, camera's, rookdetector, ...
- Très longue durée de vie
- Idéal pour par exemple appareils photos, caméras, détecteurs de fumée, ...

code				#/blister				min.	€
PS 041115		5410853017097	CR-123	1	0,017 kg	-	10	1	<b>5,20</b>
PS 041110		5410853057345	LRV08/MN21-23GA	1	0,017 kg	-	10	1	<b>2,02</b>

## Knoopcel batterijen • Piles bouton



0%

Mercury toegevoegd  
de Mercure ajouté

- Lithium Power knoopcel batterijen zijn ontworpen om een krachtig, betrouwbaar en duurzaam voeding te bieden.
- Zeer lange levensduur
- Gebruikt voor horloge, afstandsbediening, rekenmachine, fotoapparaat, ...

- Les piles bouton Lithium Power sont conçues pour fournir une alimentation puissante, fiable et durable.
- Très longue durée de vie
- Utilisé pour montres, commande à distance, calculatrice, appareil photo, ...

## CR-2016

ref. PS 041120

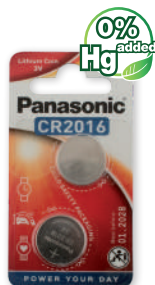

## CR-2025

ref. PS 041125



## CR-2032

ref. PS 041130



## CR-2450

ref. PS 040010



## SR44S

ref. PS 040015



code				#/blister				min.	€
PS 041120		5025232060665	CR-2016	2	0,002 kg	-	12	1	<b>3,39</b>
PS 041125		5025232060672	CR-2025	2	0,002 kg	-	12	1	<b>3,39</b>
PS 041130		5025232060689	CR-2032	2	0,003 kg	-	12	1	<b>3,39</b>
PS 040010		5000394030428	CR-2450	1	0,002 kg	-	10	1	<b>4,29</b>
PS 040015		5000394013858	SR44S	2	0,002 kg	-	10	1	<b>6,81</b>

## Blokbatteerij 6V • Batterie 6V



Panasonic

code						min.	€
LM 1100	vrac	5420000029033	4R25 K/Zn 9 Ah	510 g	864	24	<b>4,02</b>
PS 041500		5410853033141	4R25 RZ/B 7,4 Ah	700 g	-	12	<b>7,73</b>

